



**DEPARTMENT OF THE ARMY**  
CORPS OF ENGINEERS, NEW ORLEANS DISTRICT  
P. O. BOX 60267  
NEW ORLEANS, LOUISIANA 70160-0267

REPLY TO  
ATTENTION OF:

Operations Division  
Western Evaluation Section  
Project Manager  
Darlene Herman  
(504) 862-2287  
Darlene.C.Herman@usace.army.mil

SUBJECT: MVN 1997-3061-4 WB

**PUBLIC NOTICE**

Interested parties are hereby notified that an application has been received by the District engineer for a Department of the Army permit to authorize the following pursuant to (X) Section 10 of the Rivers and Harbors Act of March 3, 1899 (30 Stat. 1151; 33 USC 403); and/or () Section 404 of the Clean Water Act (86 Stat. 816; 33 USC 1344).

**ARTIFICIAL REEF IN THE GULF OF MEXICO**

**NAME OF APPLICANT:** Louisiana Department of Wildlife and Fisheries, Artificial Reef Program, Post Office Box 98000, Baton Rouge, Louisiana 70808.

**LOCATION OF WORK:** In the Gulf of Mexico, South Marsh Island 77, off the coast of St. Mary Parish, Louisiana, as shown on the attached drawings.

**CHARACTER OF WORK:** Deploy McMoRan Oil & Gas South Marsh 49 –A jacket in the South Marsh Island 77 artificial reef site to provide structural habitat for the purpose of enhancing fishing opportunities in the Gulf of Mexico. Clearance from the top of the deployed platform jacket to the water surface will be approximately 63 feet. This request is pursuant to Act 100, 1986 Louisiana Legislature and the National Fishing Enhancement Act of 1984.

The comment period for the Department of the Army Permit will close **15 days** from the date of this joint public notice. Written comments, including suggestions for modifications or objections to the proposed work, stating reasons thereof, are being solicited from anyone having interest in this permit and must be submitted so as to be received before or by the last day of the comment period. Letters concerning the Corps of Engineers permit application must reference the applicant's name and the Permit Application Number, and be forwarded to the Corps of Engineers at the address above, **ATTENTION: REGULATORY BRANCH.**

The decision whether to issue a permit will be based on an evaluation of the probable impact including cumulative impacts of the proposed activity on the public interest. That decision will reflect the national concern for both protection and utilization of important resources. The benefit which reasonably may be expected to accrue from the proposal must be balanced against its reasonably foreseeable detriments. All factors which may be relevant to the proposal will be considered including the cumulative effects thereof; among those are conservation, economics, aesthetics, general environmental concerns, wetlands, historic properties, fish and wildlife values, flood hazards, floodplain values, land use, navigation, shoreline erosion and accretion, recreation, water supply and conservation, water quality, energy needs, safety, food and fiber production, mineral needs, consideration of property ownership and, in general, the needs and welfare of the people.

The Corps of Engineers is soliciting comments from the public; federal, state, and local agencies and officials; Indian Tribes; and other interested parties in order to consider and evaluate the impacts of this proposed activity. Any comments received will be considered by the Corps of Engineers to determine whether to issue, modify, condition or deny a permit for this proposal. To make this decision, comments are used to assess impacts on endangered species, historic properties, water quality, general environmental effects, and the other public interest factors listed above. Comments are used in the preparation of an Environmental Assessment and/or Environmental Impact Statement pursuant to the National Environmental Policy Act. Comments are also used to determine the need for a public hearing and to determine the overall public interest of the proposed activity.

The New Orleans District is unaware of properties listed on the National Register of Historic Places near the proposed work. The possibility exists that the proposed work may damage or destroy presently unknown archeological, scientific, rehistorical, historical sites, or data. Issuance of this public notice solicits input from State Archeologist and State Historic Preservation Officer regarding potential impacts to cultural resources.

Our initial finding is that the proposed work would neither affect any species listed as endangered by the U.S. Department of Interior nor affect any habitat designated as critical to the survival and recovery of any endangered species.

This notice initiates the Essential Fish Habitat (EFH) consultation requirements of the Magnus-Stevens Fishery Conservation and Management Act. The applicant's proposal would result in the destruction or alteration of 0 acre(s) of EFH utilized by various life stages of red drum and penaeid shrimp. Our initial determination is that the proposed action would not have a substantial adverse impact on EFH or federally managed fisheries in the Gulf of Mexico. Our final determination relative to project impacts and the need for mitigation measures is subject to review by and coordination with the National Marine Fisheries Service.

If the proposed work involves deposits of dredged or fill material into navigable waters, the evaluation of the probable impacts will include the application of guidelines established by the Administrator of the Environmental Protection Agency and certification that the proposed activity will not violate applicable water quality standards will be required from the Louisiana Department of Environmental Quality, Office of Environmental Services, before a permit is issued.

Any person may request, in writing, within the comment period specified in this notice, that a public hearing be held to consider this application. Requests for public hearings shall state, with particularity, the reasons for holding a public hearing.

You are requested to communicate the information contained in this notice to any other parties whom you deem likely to have interest in the matter.

The applicant has certified that the proposed activity described in the application complies with and will be conducted in a manner that is consistent with the Louisiana Coastal Resources Program. The Department of the Army permit will not be issued unless the applicant received approval or a waiver of the Coastal Use Permit by the Department of Natural Resources.



Darrell S. Barbara  
Chief, Western Evaluation Section  
Regulatory Branch

Attachments

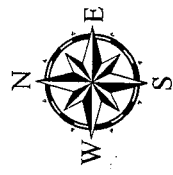
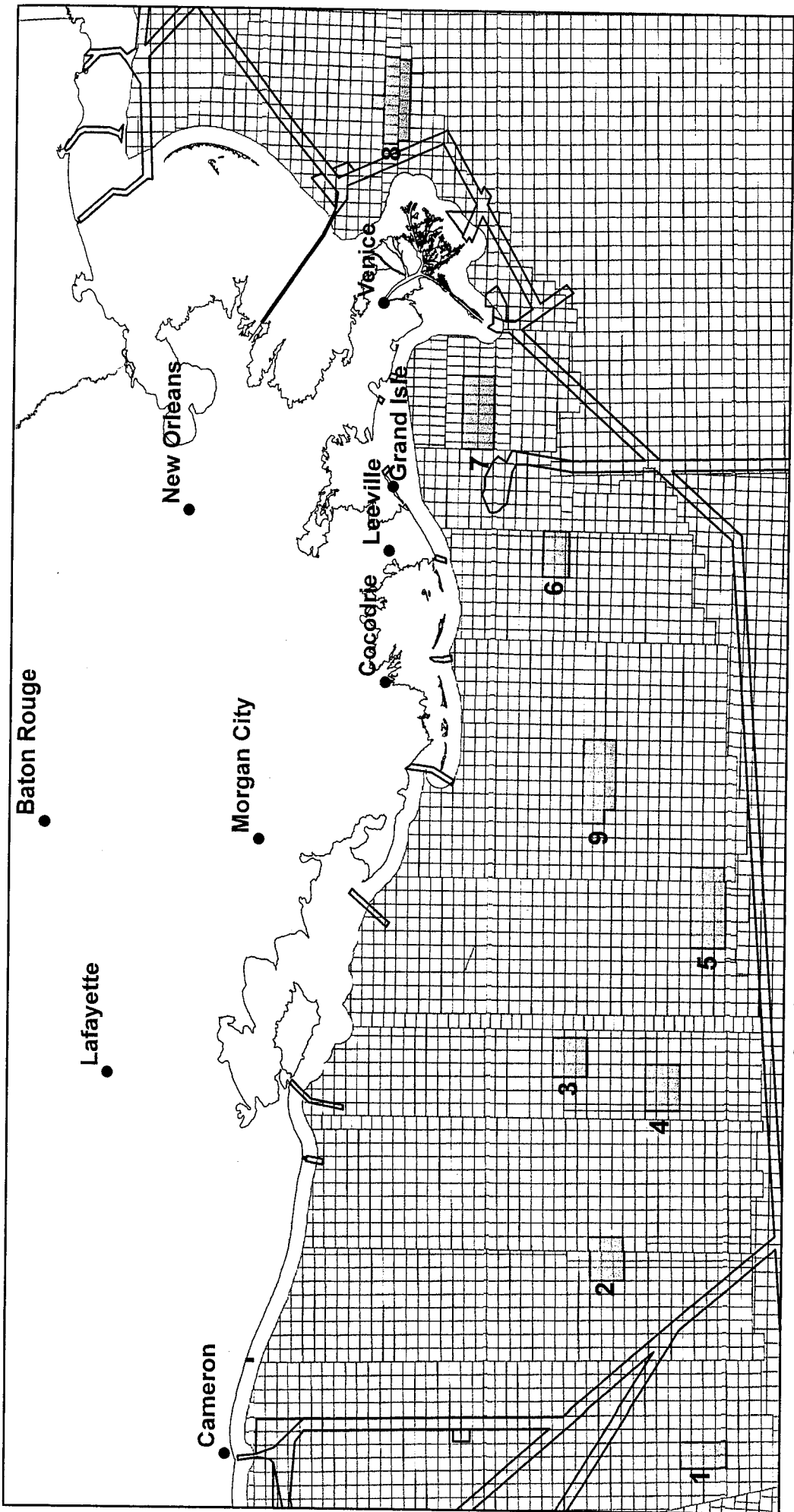
# Louisiana Artificial Reef Planning Areas



- | Planning Areas                            |                                  |
|---|----------------------------------|
| 1. West Cameron Planning Area             | 6. South Timbalier Planning Area |
| 2. East Cameron Planning Area             | 7. West Delta Planning Area      |
| 3. South Marsh Island (76) Planning Area  | 8. Main Pass Planning Area       |
| 4. South Marsh Island (146) Planning Area | 9. Ship Shoal Planning Area      |
| 5. Eugene Island Planning Area            |                                  |

-  Planning Areas
-  Fairways
-  OCS Blocks

# Louisiana Artificial Reef Program

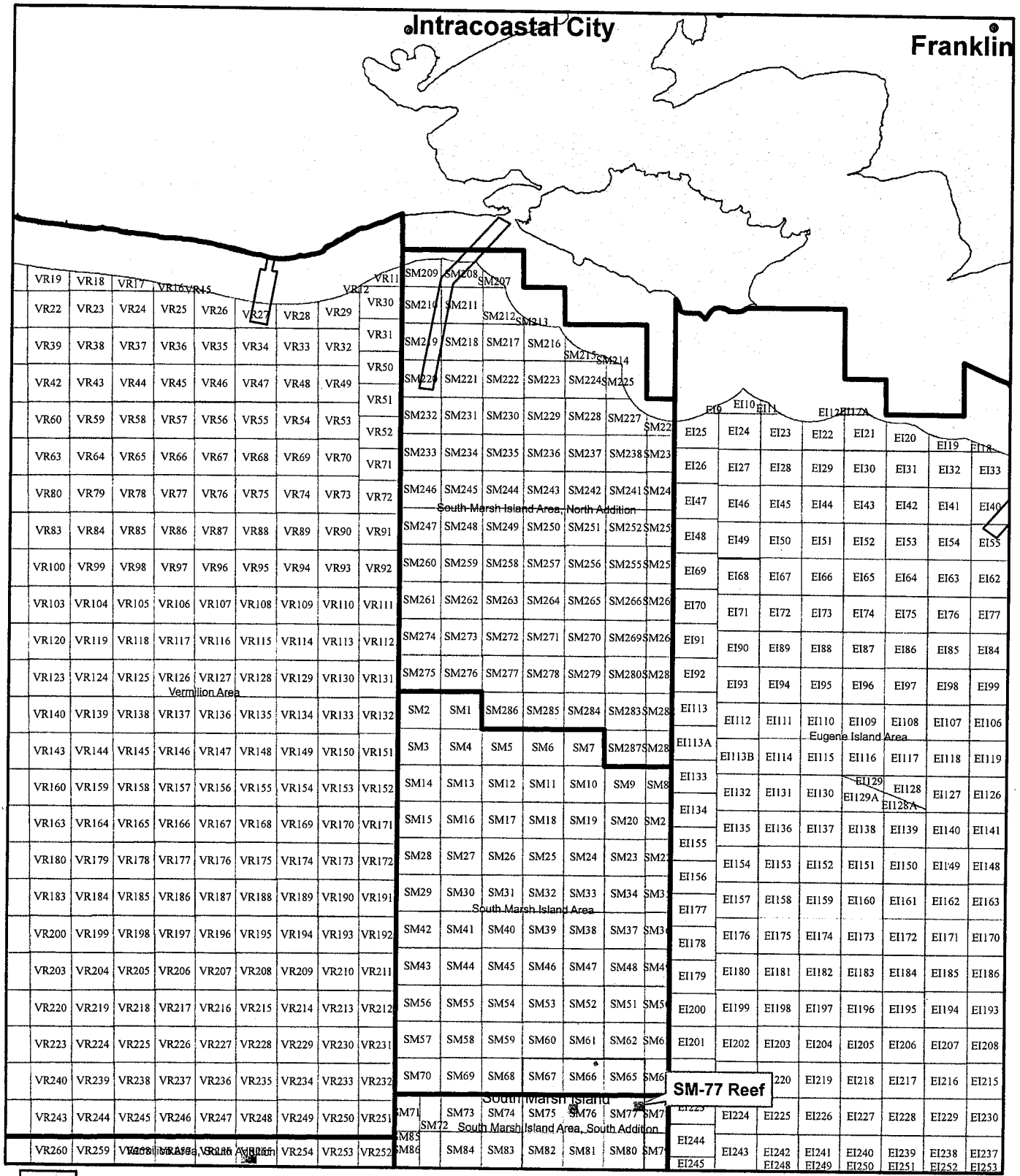

- Planning Area
- Permitted Reef Sites
- Fairways
- OCS Blocks

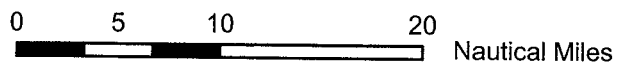

SM-77 Reef Vicinity Map

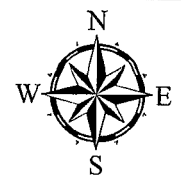

SOUTH MARSH ISLAND AREA

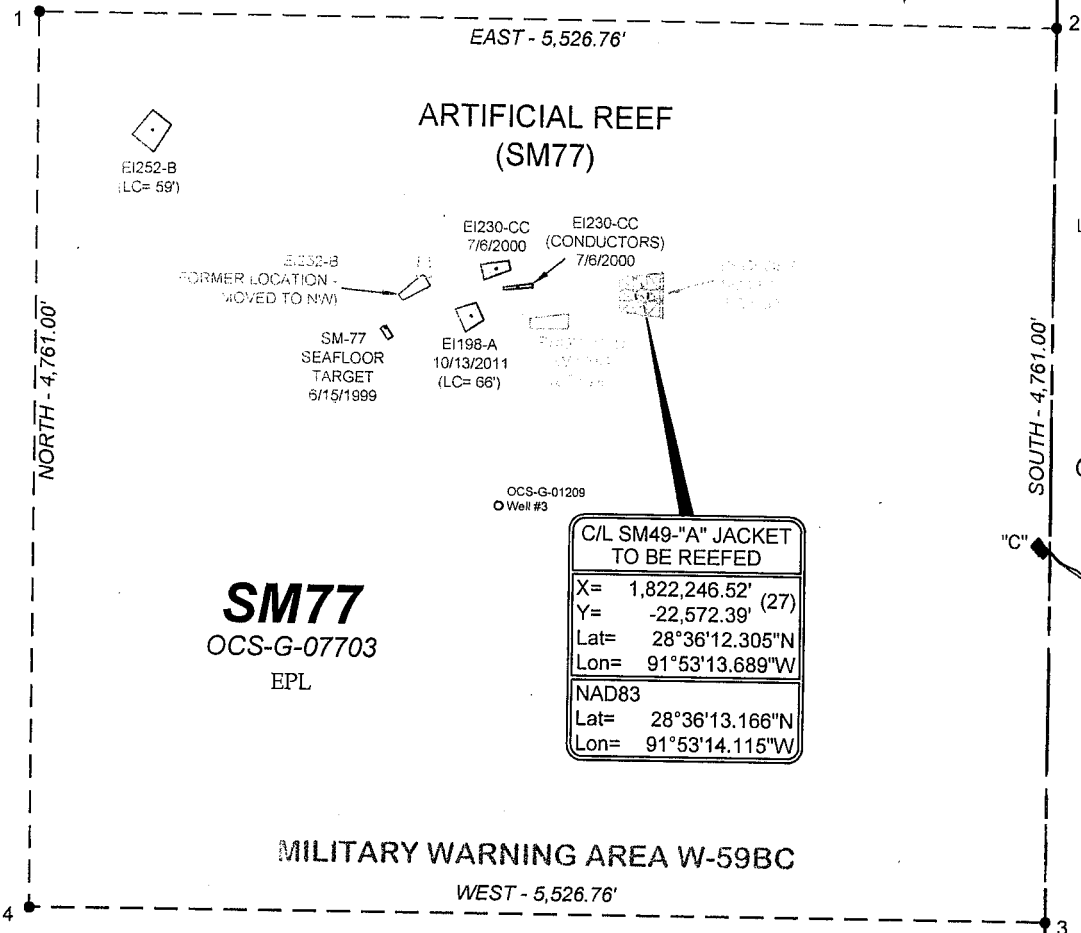

**C/L SM49-"A" JACKET TO BE REEFED**

X= 1,822,246.52' (27)  
Y= -22,572.39'  
Lat= 28°36'12.305"N  
Lon= 91°53'13.689"W

NAD83  
Lat= 28°36'13.166"N  
Lon= 91°53'14.115"W

**SM77**  
OCS-G-07703  
EPL

**EXISTING ARTIFICIAL REEF BOUNDARY**

POINT	CORNER	X COORDINATE	Y COORDINATE	LATITUDE	LONGITUDE
1	NW	1,818,952.00'	-21,115.00'	28°36'26.573"N	91°53'50.720"W
2	NE	1,824,478.76'	-21,115.00'	28°36'26.838"N	91°52'48.731"W
3	SE	1,824,478.76'	-25,876.00'	28°35'39.710"N	91°52'48.476"W
4	SW	1,818,952.00'	-25,876.00'	28°35'39.445"N	91°53'50.458"W

NOTES:  
 1. NADCON 2.1 USED FOR CONVERSIONS BETWEEN WGS84 AND NAD27.  
 2. INFORMATION SHOWN IS FROM C&C TECHNOLOGIES, INC.'S DATABASE AND / OR OTHER SOURCES AND MAY NOT DEPICT THEIR ACTUAL LOCATION. OTHER PIPELINES AND HAZARDS MAY EXIST THAT ARE NOT SHOWN.

DATE: 04/06/2015 TIME: 16:32 FILENAME: M:\150301\ACAD\150301-REEF-02.DWG

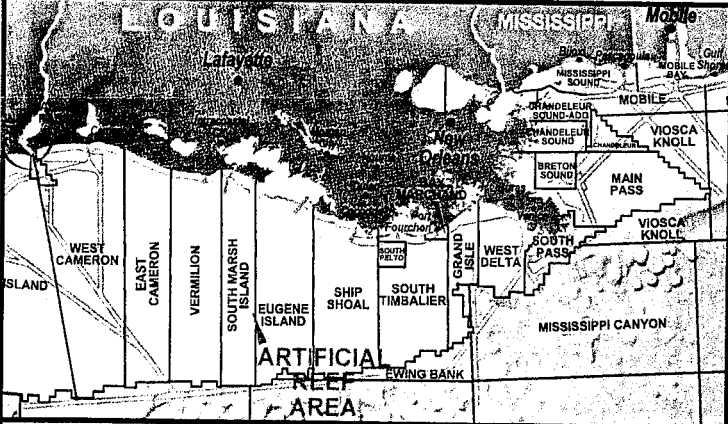

**SM49 - "A"**  
**IN PROPOSED REEF POSITION**  
**Block 77**  
**South Marsh Island Area**

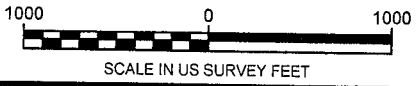

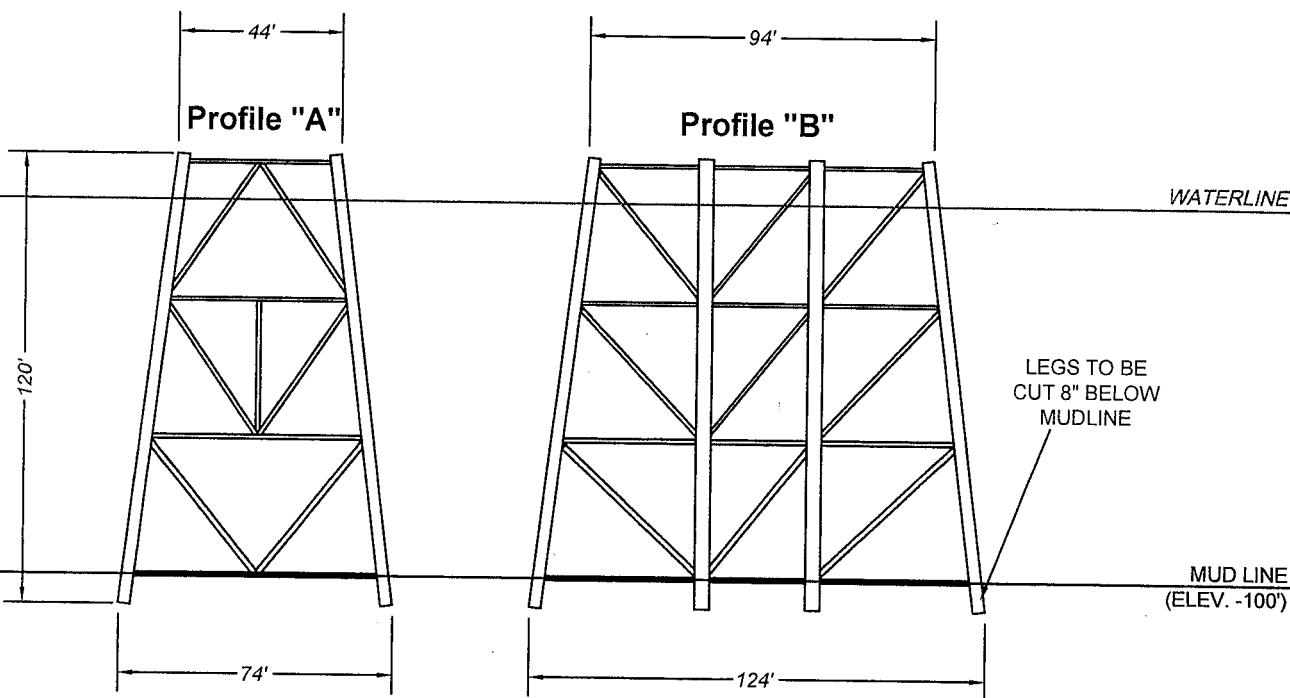
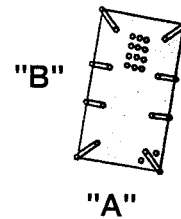

**PROFILES "A" & "B"** (note: 1 structure, 2 aspects)  
(PRE-DEPLOYMENT)

NOTES:  
 1. NADCON 2.1 USED FOR CONVERSIONS BETWEEN WGS84 AND NAD27.  
 2. INFORMATION SHOWN IS FROM C&C TECHNOLOGIES, INC.'S DATABASE AND / OR OTHER SOURCES AND MAY NOT DEPICT THEIR ACTUAL LOCATION. OTHER PIPELINES AND HAZARDS MAY EXIST THAT ARE NOT SHOWN.

DATE: 04/06/2015 TIME: 16:24 FILENAME: M:\150301\ACAD\150301-REEF-03.DWG

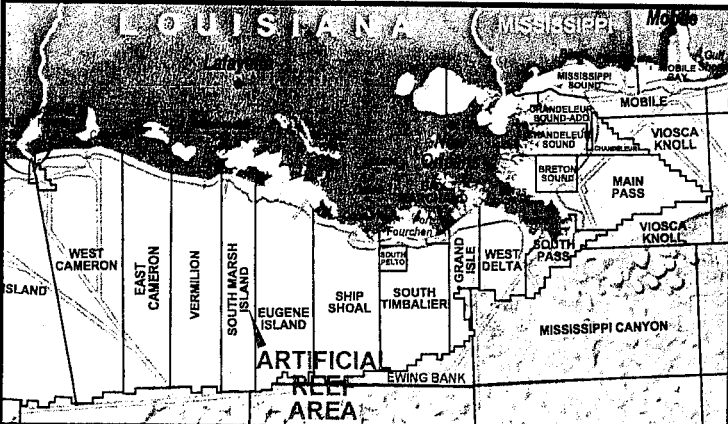

SM49 - "A"  
 TO BE REEFED  
 Block 77  
 South Marsh Island Area

PREPARED BY:  C&C Technologies SURVEY SERVICES 730 E. KALISTE SALOOM RD. LAFAYETTE, LA 70508 (337) 210-0000 LA Reg. No. 330	JOB No: 150301	BY: JRD	DATE: Apr. 6, 2015	REV.
	FILENAME: 150301-REEF-03.DWG	SHEET 3 of 4		2

WATERLINE

Established and Charted  
Reef Clearance: 51-ft

Proposed Structure Clearance 63-ft

63'  
74'

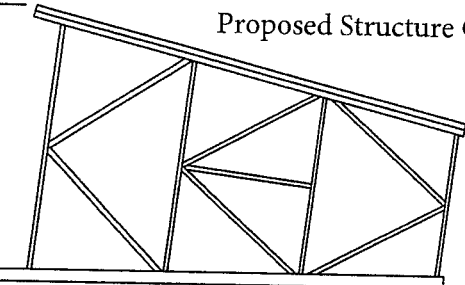

MUD LINE  
(ELEV. -137')

### PROFILE "C" (POST-DEPLOYMENT)

**NOTES:**

- 1. NADCON 2.1 USED FOR CONVERSIONS BETWEEN WGS84 AND NAD27.
- 2. INFORMATION SHOWN IS FROM C&C TECHNOLOGIES, INC.'S DATABASE AND / OR OTHER SOURCES AND MAY NOT DEPICT THEIR ACTUAL LOCATION. OTHER PIPELINES AND HAZARDS MAY EXIST THAT ARE NOT SHOWN.

DATE: 04/06/2015 TIME: 16:25 FILENAME: M:\150301\ACAD\150301-REEF-04.DWG

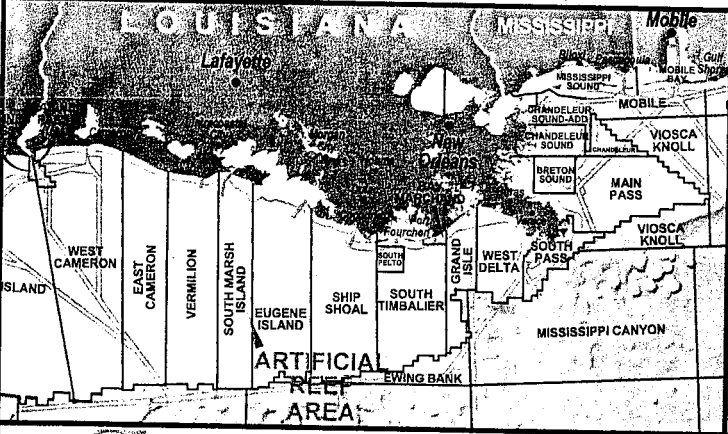

**McMoran Oil & Gas LLC**

**SM49 - "A"**  
**IN PROPOSED REEF POSITION**  
**Block 77**  
**South Marsh Island Area**

PREPARED BY:  <b>C&amp;C Technologies</b> SURVEY SERVICES	730 E. KALISTE SALOOM RD. LAFAYETTE, LA 70508 (337) 210-0000 LA Reg. No. 330	JOB No: 150301	BY: JRD	DATE: Apr. 6, 2015	REV.
		FILENAME: 150301-REEF-04.DWG		SHEET 4 of 4	2